

# balancing station Kaja



Age indication



Balance



Living together

## Scope of delivery



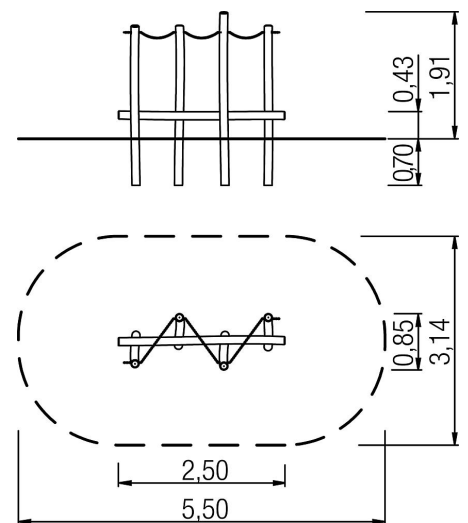



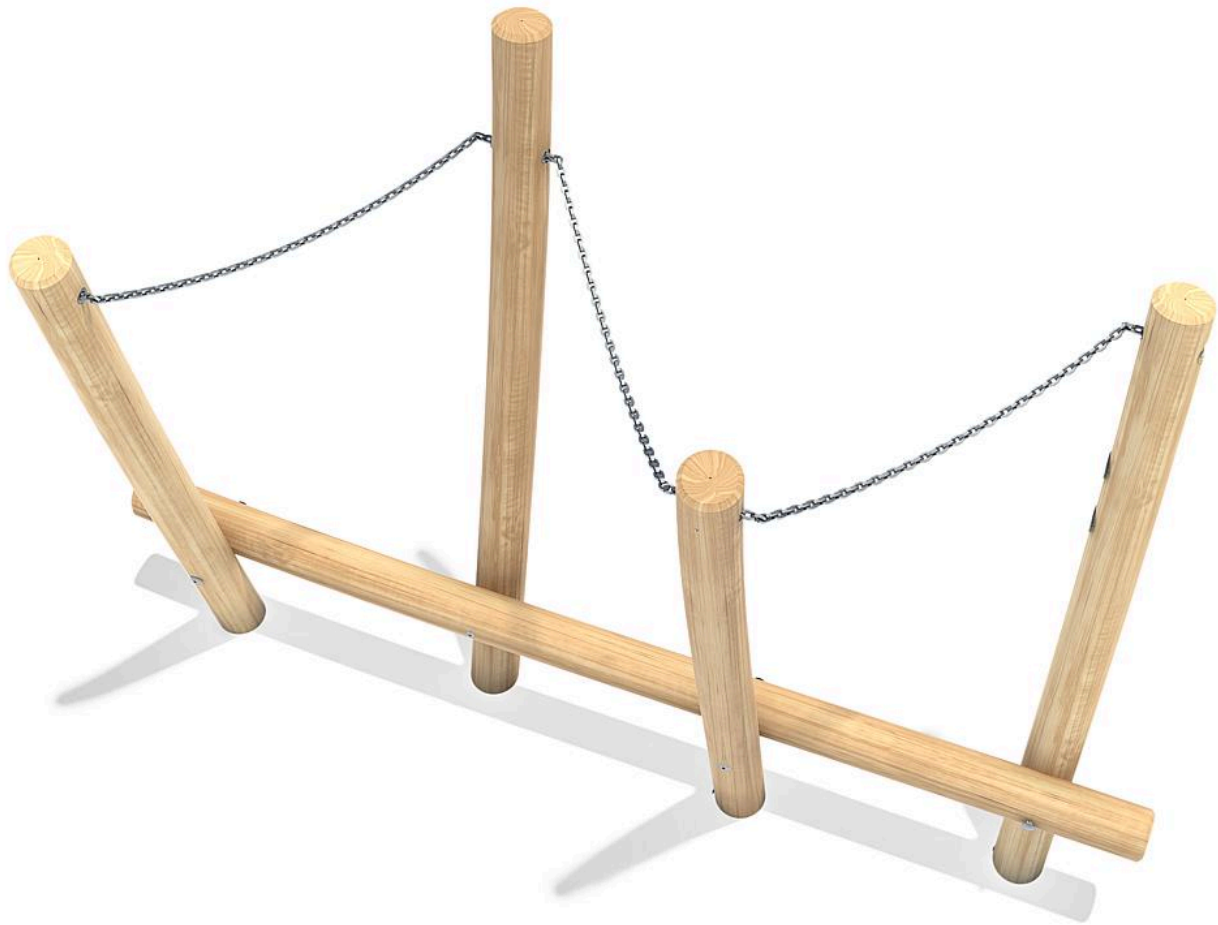



1x balancing element zigzag: robinia, stainless steel (V2A)  
fittings: stainless steel (V2A)













# balancing station Kaja



## Technical data

	Material	Robinia natural
	Minimum space	5,50x3,14x2,23 m
	Impact protection net	-
	Free falling height	43 cm
	Ground constitution GE/NL/B	at least stone
	Ground constitution all except GE/NL/B	at least stone
	Largest section	250x85x261 cm
	mx. number of users	7
	Certificate	Z2_010651_0535_Rev00
	Tested according to standard	EN 1176 - 1/7

## Installation information

	Foundations	4x CF
	Fundamentlevel	ET 700
	Assembly	2 persons/2 h
	PF Accessories	-
	PF drainage	-
	PF concrete	-
	PF excavation	-
	CF Accessories	-
	CF drainage	0,16 m <sup>3</sup>
	CF concrete	0,44 m <sup>3</sup>
	CF excavation	1,16 m <sup>3</sup>



5 45 433 063 00

# balancing station Kaja

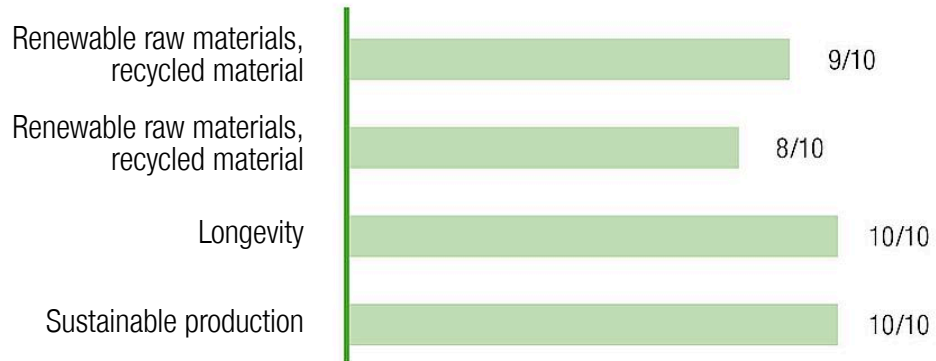

**CO<sub>2</sub> emissions of the product**

**37,4 kg**

**Material share of renewable raw materials**

**97%**

**Recyclate content**

**3%**

Circularity score

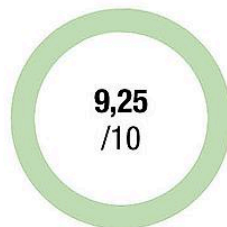

Weighted emission factor of the product\*



**Disclaimer:**

This dashboard for the circularity index of the 'Circular Product' certification was generated automatically and is based on the corresponding certification of eibe Produktion + Vertrieb GmbH & Co KG, Industriestraße 1, 97285 Röttingen, which was issued on 16 May 2024 by the Gesellschaft für Klimaschutz München GmbH (GKM GmbH) on the basis of the example product Albion play unit from the eibe unique® product line. eibe Produktion + Vertrieb GmbH & Co KG is liable for the accuracy of the contents. The award criteria of the private-law certification 'Circular Product' of GKM GmbH can be viewed at [gesellschaft-klimaschutz.de/zertifizierung/zirkularitaet/](https://gesellschaft-klimaschutz.de/zertifizierung/zirkularitaet/).

\* The CO<sub>2</sub>e emissions of the materials used in the product are taken into account. The emissions that arise during the production process are allocated to the product on a pro-rata basis.

created on: 14 August 2024