

Mini play house London

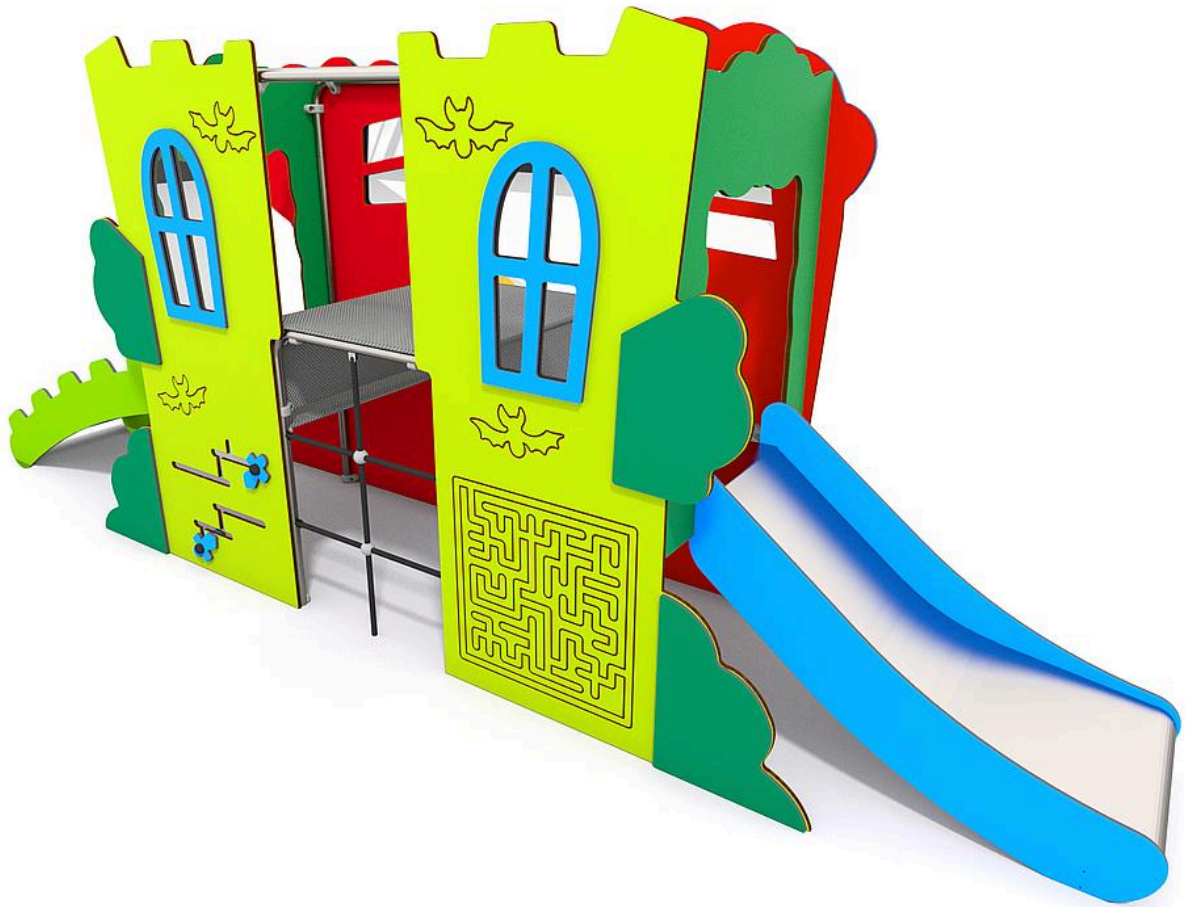

Age indication



Social skills



Imagination



Speed



Balance



Fitness

Scope of delivery

Play house consisting of:

1x play wall castle: high-pressure laminate (HPL), HDPE

1x play wall bus: high-pressure laminate (HPL), HDPE

1x ramp: HDPE

1x rung net: polypropylen

1x play house frame: stainless steel

1x slide ph 90 cm: stainless steel, HDPE



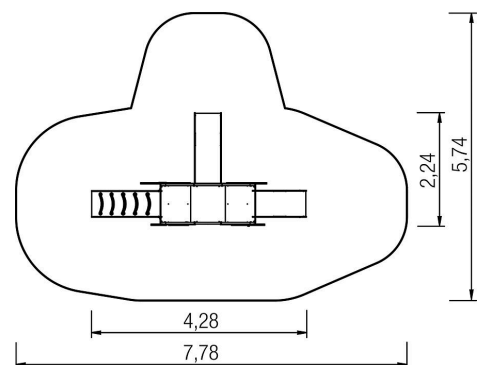





1x slide small ph 60 cm: HDPE, polyester





Mini play house London



Technical data

	Material	Stainless steel, HDPE, HPL
	Minimum space	7,78x5,74x2,70 m
	Impact protection net	31,0 m ²
	Free falling height	90 cm
	Ground constitution DE/NL/BE	at least top soil
	Ground constitution all except DE/NL/BE	at least top soil
	Size	4,28x2,24x1,69 m
	mx. number of users	14

Installation information

	Foundations	10x CF
	Fundamentlevel	FL 3