

5 40 313 101 30

# Attachment slide wide PH 145 cm



Age indication



Speed

## Scope of delivery



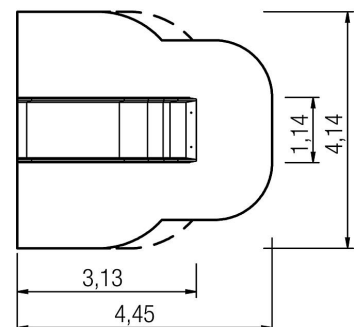
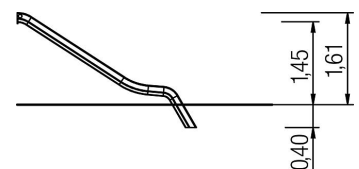



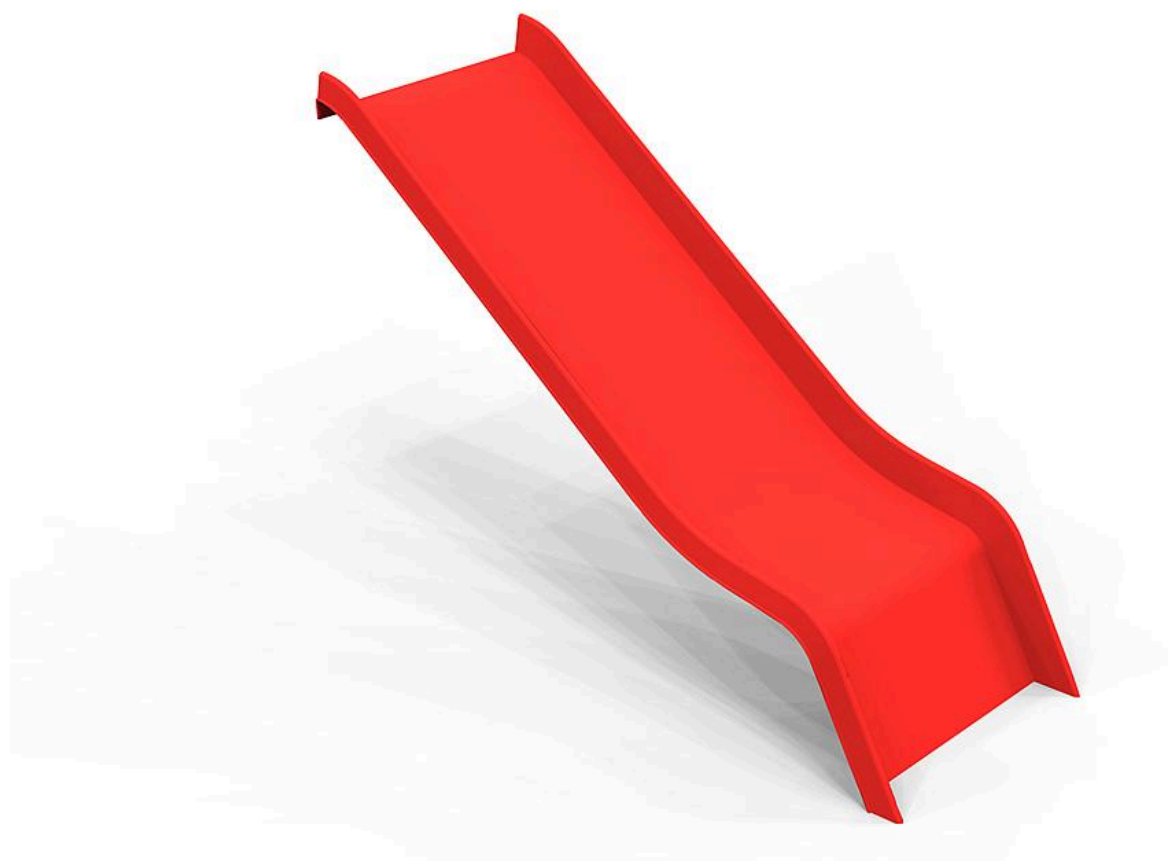

1x slide: glass fibre reinforced plastic (GFRP)  
fittings: stainless steel (V2A)













# Attachment slide wide PH 145 cm



## Technical data

	Material	GFRP
	Minimum space	4,45x4,14x3,25 m
	Impact protection net	16,0 m <sup>2</sup>
	Free falling height	145 cm
	Ground constitution DE/NL/BE	at least lawn
	Ground constitution all except DE/NL/BE	at least sand
	mx. number of users	2
	Tested according to standard	EN 1176 - 1/3/7

## Installation information

	Foundations	1x CF or 1x PFs
	Fundamentlevel	ET 400
	Assembly	2 persons/0,25 h
	PF Accessories	1x 5632540
	PF drainage	-
	PF concrete	-
	PF excavation	0,10 m <sup>3</sup>
	CF Accessories	1x 5631120
	CF drainage	-
	CF concrete	0,12 m <sup>3</sup>
	CF excavation	0,28 m <sup>3</sup>



5 40 313 101 30

# Attachment slide wide PH 145 cm



**CO<sub>2</sub> emissions of the product**

**431,3 kg**

**Material share of renewable raw materials**

**0%**

**Recyclate content**

**1%**

Circularity score



Weighted emission factor of the product\*



**Disclaimer:**

This dashboard for the circularity index of the 'Circular Product' certification was generated automatically and is based on the corresponding certification of eibe Produktion + Vertrieb GmbH & Co KG, Industriestraße 1, 97285 Röttingen, which was issued on 16 May 2024 by the Gesellschaft für Klimaschutz München GmbH (GKM GmbH) on the basis of the example product Albion play unit from the eibe unique® product line. eibe Produktion + Vertrieb GmbH & Co KG is liable for the accuracy of the contents. The award criteria of the private-law certification 'Circular Product' of GKM GmbH can be viewed at [gesellschaft-klimaschutz.de/zertifizierung/zirkularitaet/](https://gesellschaft-klimaschutz.de/zertifizierung/zirkularitaet/).

\* The CO<sub>2</sub>e emissions of the materials used in the product are taken into account. The emissions that arise during the production process are allocated to the product on a pro-rata basis.

created on: 14 August 2024