

5 55 334 5

unique swing Snake







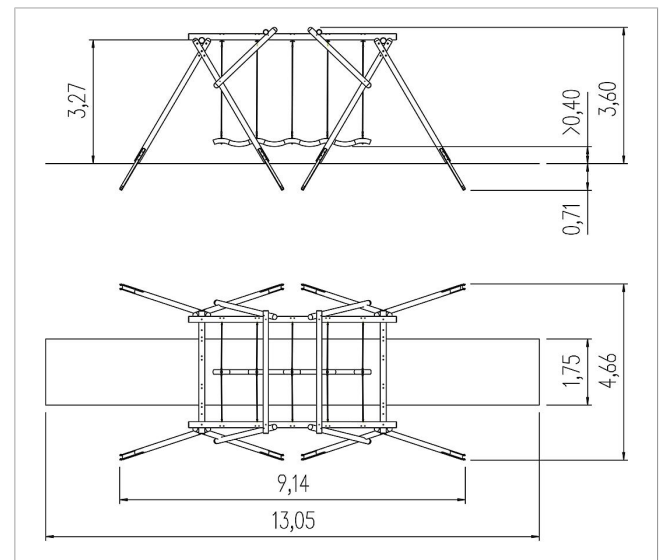

made in germany



Scope of delivery

1x swing frame: softwood
1x swing snake: plastic-coated steel rope
post shoe: galvanised steel



	Material	SW pi
	Foundation level	ET 800
	Minimum space	13,05x4,60x4,05 m
	Free falling height	205 cm
	Impact protection net	23,0 m ²
	Foundations	8x CF
	Assembly	2 persons/8 h
	Largest section	Ø 16x550 cm
	Heaviest section	50 kg