

5 11 561 013 00

**ecorino Voice pipe
Cotopaxi**







made in germany

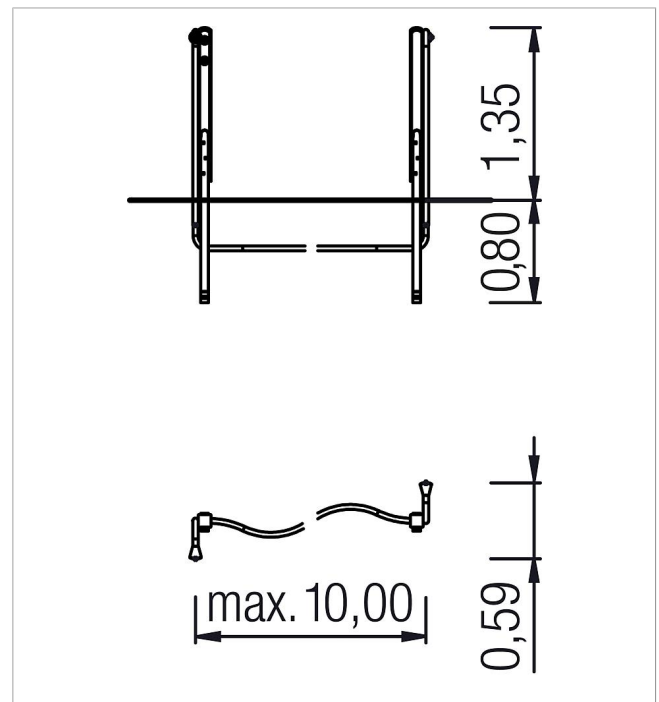

Scope of delivery

2x post construction: softwood, steel
2x voice pipe: stainless steel
1x spiral hose: PVC



| | | |
|---|-----------------------|-------------------|
|  | Material | SW pi |
|  | Foundation level | ET 700 |
|  | Minimum space | 10,00x0,59x1,35 m |
|  | Free falling height | - |
|  | Impact protection net | - |
|  | Foundations | 2x CF |
|  | Assembly | 2 persons/2 h |