

# play house Alpine Rose



Age indication



Speed



Fitness



Social skills



Imagination

## Scope of delivery



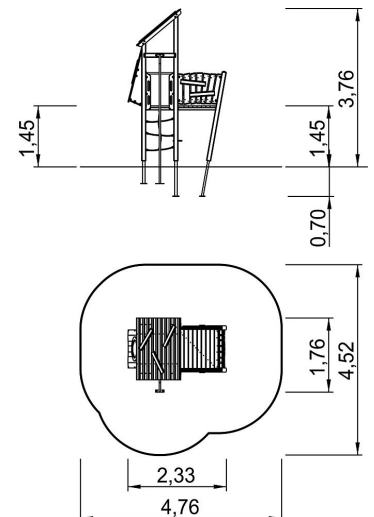







- 2x post construction sloped: softwood
- 4x post construction: softwood or steel
- 4x post shoe: steel galvanised
- 2x platform construction: softwood
- 1x 3D parapet: high pressure laminate (HPL), NH, Makrolon
- 3x parapet: softwood
- 1x parapet: high pressure laminate (HPL)
- 9x decoration crossbar: softwood
- 1x walk-through protective device: stainless steel
- 1x set of grips: aluminium, plastic coated
- 2x protective device clamping of hood cord: high pressure laminate (HPL)
- 1x net ascent vertical: polyester-coated steel cable
- 1x pent roof: softwood
- 1x fireman's pole: stainless steel
- 1x play panel dice disc: high pressure laminate (HPL), steel galvanised
- 1x counter: softwood, high pressure laminate (HPL)
- 1x access restriction: high pressure laminate (HPL)
- fittings: stainless steel













# play house Alpine Rose



## Technical data

	Material	SW pi
	Minimum space	4,52x4,76x3,76 m
	Impact protection net	18,0 m <sup>2</sup>
	Free falling height	145 cm
	Ground constitution DE/NL/BE	at least turf
	Ground constitution all except DE/NL/BE	at least sand
	Largest section	0,15x0,15x4,39 m
	mx. number of users	11
	Certificate	Z2_010651_514_Rev00
	Tested according to standard	EN 1176 - 1/7
	Service interval (in months)	3

## Installation information

	Foundations	3x CF or 3x PFs
	Fundamentlevel	ET 400/700
	Assembly	2 persons/7.5 h
	PF Accessories	3x 5632540
	PF drainage	0,27 m <sup>3</sup>
	PF concrete	0,80 m <sup>3</sup>
	PF excavation	2,83 m <sup>3</sup>
	CF Accessories	3x 5631120
	CF drainage	0,27 m <sup>3</sup>
	CF concrete	0,95 m <sup>3</sup>
	CF excavation	2,48 m <sup>3</sup>

Legend: PF=prefabricated foundation, CF=concrete foundation, ET=burial depth, GFRP=glass-fibre reinforced plastic, VA=stainless steel, PH=platform height



5 11 514 011 00

# play house Alpine Rose



**CO<sub>2</sub> emissions of the product**

**644,3 kg**

**Material share of renewable raw materials**

**75%**

**Recyclate content**

**11%**

Circularity score



Weighted emission factor of the product\*

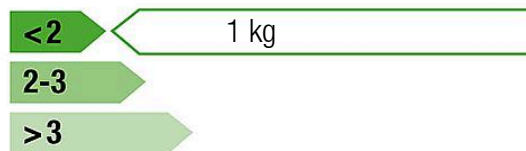

**Disclaimer:**

This dashboard for the circularity index of the 'Circular Product' certification was generated automatically and is based on the corresponding certification of eibe Produktion + Vertrieb GmbH & Co KG, Industriestraße 1, 97285 Röttingen, which was issued on 16 May 2024 by the Gesellschaft für Klimaschutz München GmbH (GKM GmbH) on the basis of the example product Albion play unit from the eibe unique® product line. eibe Produktion + Vertrieb GmbH & Co KG is liable for the accuracy of the contents. The award criteria of the private-law certification 'Circular Product' of GKM GmbH can be viewed at [gesellschaft-klimaschutz.de/zertifizierung/zirkularitaet/](https://gesellschaft-klimaschutz.de/zertifizierung/zirkularitaet/).

\* The CO<sub>2</sub>e emissions of the materials used in the product are taken into account. The emissions that arise during the production process are allocated to the product on a pro-rata basis.

created on: 14 August 2024