

5 58 411 0

# Slide with ladder PH 190 cm



Age indication



Fitness



Speed

## Scope of delivery

1x slide PH 195 cm: GFRP  
1x slide ascent: galvanised steel

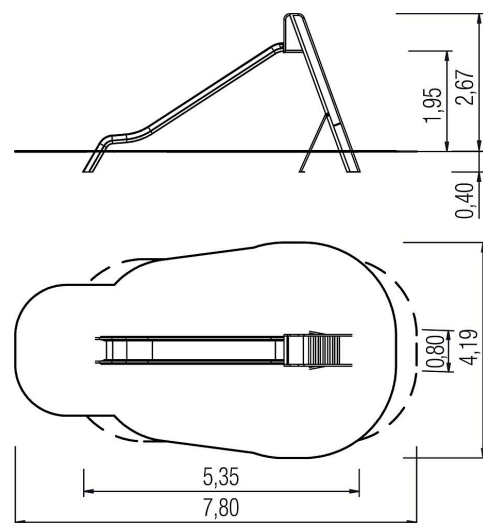











5 58 411 0





# Slide with ladder PH 190 cm



## Technical data

	Material	steel, GFRP
	Minimum space	7,90x4,68x3,75 m
	Impact protection net	27,0 m <sup>2</sup>
	Free falling height	195 cm
	Ground constitution DE/NL/BE	at least sand
	Ground constitution all except DE/NL/BE	at least sand
	Size	5,37x0,81x2,67 m
	Largest section	385x54x20 cm
	Heaviest section	50 kg
	Certificate	-
	Tested according to standard	-

## Installation information

	Foundations	5x CF or 5x PFs
	Fundamentlevel	ET 400
	Assembly	2 persons/1 h
	PF Accessories	5x 5632540



5 58 411 0

# Slide with ladder PH 190 cm



**CO<sub>2</sub> emissions of the product**

**334,1 kg**

**Material share of renewable raw materials**

**1%**

**Recyclate content**

**92%**

Circularity score



Weighted emission factor of the product\*



**Disclaimer:**

This dashboard for the circularity index of the 'Circular Product' certification was generated automatically and is based on the corresponding certification of eibe Produktion + Vertrieb GmbH & Co KG, Industriestraße 1, 97285 Röttingen, which was issued on 16 May 2024 by the Gesellschaft für Klimaschutz München GmbH (GKM GmbH) on the basis of the example product Albion play unit from the eibe unique® product line. eibe Produktion + Vertrieb GmbH & Co KG is liable for the accuracy of the contents. The award criteria of the private-law certification 'Circular Product' of GKM GmbH can be viewed at [gesellschaft-klimaschutz.de/zertifizierung/zirkularitaet/](https://gesellschaft-klimaschutz.de/zertifizierung/zirkularitaet/).

\* The CO<sub>2</sub>e emissions of the materials used in the product are taken into account. The emissions that arise during the production process are allocated to the product on a pro-rata basis.

created on: 14 August 2024