

5 55 010 5

unique hexagonal system 210







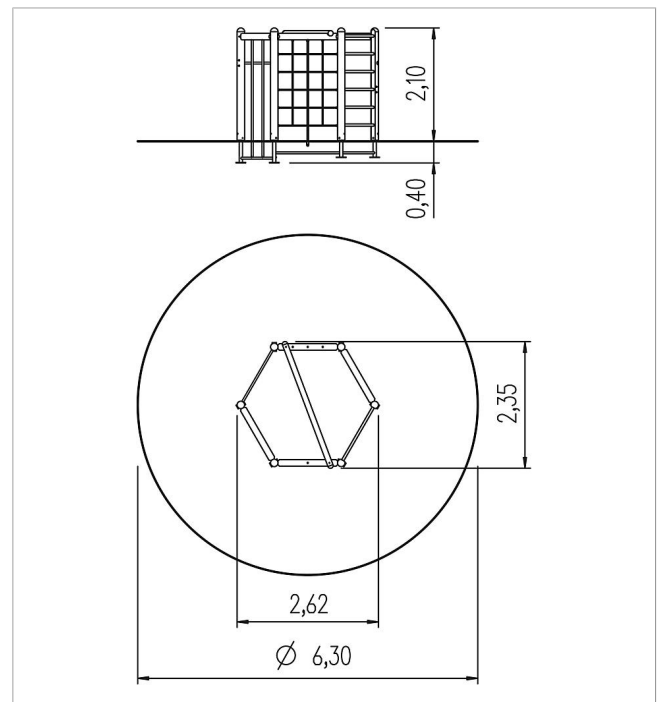

made in germany



Scope of delivery

1x rung element: softwood, ash
 2x horizontal bar: galvanised and powder-coated steel
 2x firemans pole: powder-coated steel
 1x climbing net: plastic-coated steel cable
 1x climbing rope: plastic-coated cable
 wood structure H 200 cm: softwood
 post bases: galvanised steel



	Material	SW pi
	Foundation level	ET 400
	Minimum space	6,37x6,02x2,10 m
	Free falling height	205 cm
	Impact protection net	30,5 m ²
	Foundations	6x CF or 6x PFs
	Assembly	2 persons/3 h
	Largest section	250x139x14 cm
	Heaviest section	120 kg